

GENTEX CORPORATION

A Smarter Vision®

HD135 SERIES



135°F FIXED TEMPERATURE HEAT ALARM, AC POWERED WITH BATTERY BACKUP, 120VAC/9VDC, 60Hz OR 220VAC/9VDC, 50/60Hz

Installation Instructions - Owner's Information READ CAREFULLY AND SAVE

INTRODUCTION HD135

The HD135 Series heat alarm is for use as an evacuation device in residential applications. Each alarm has a solid state piezo that emits a temporal 3 signal to warn and alert the household to the presence of threatening heat.

Your heat alarm is designed to detect heat that results from an actual fire. Heat alarms are intended for use as supplements to smoke alarms. This unit cannot detect smoke or other toxic gases, therefore, do not rely solely on this heat alarm to provide warning of a fire.

BASIC SAFETY INFORMATION

Dangers, Warnings, Cautions and Notices alert you to important operating procedures or to potentially hazardous situations. Pay special attention to these items.

WARNING

- ◆ This heat alarm is listed for use in single-family and multi-family residences, along with hotels, motels and other commercial residential occupancies.
- ◆ NEVER ignore your heat alarm if it sounds. Failure to do so can result in serious injury or death.
- ◆ Test this device once a week per manufacturer installation recommendation. If the device ever fails to test correctly, replace immediately! If the device is not working properly, it cannot alert you to a problem.
- ◆ This product is intended for use in indoor locations of family dwelling units.

MODELS

(SEE BACK OF HEAT ALARM FOR EXACT MODEL)

- *HD135.....120VAC, 60Hz with Temporal 3 Horn
- *HD135-223.....220VAC, 50/60Hz with Temporal 3 Horn

* Per NFPA 72, the *American National Standard Audible Emergency Evacuation Signal* as defined in ANSI S3.41, is required whenever the intended response is to evacuate the building.

NOTICE: IN THE EVENT AC POWER FAILS, A 9VDC BATTERY WILL PROVIDE PROPER ALARM OPERATION FOR A MINIMUM OF A 24-HOUR PERIOD.

ELECTRICAL SPECIFICATIONS

OPERATING VOLTAGE.....	120VAC, 60Hz
OPERATING CURRENT (MAX.) (120VAC/9VDC).....	0.035 amps
OPERATING VOLTAGE.....	220VAC, 50/60Hz
OPERATING CURRENT (MAX.) (220VAC/9VDC).....	0.035 amps
OPERATING AMBIENT TEMPERATURE RANGE.....	40°F to 100°F
ALARM HORN RATING.....	meets or exceeds 85 dBA at 10 feet

MUST USE DURACELL® MN 1604 BATTERY

HOW TO TELL IF YOUR HEAT ALARM IS WORKING PROPERLY

- ◆ Your heat alarm is provided with an alarm horn and pulsating Light Emitting (indicator) Diode, which pulses every 30 seconds and a green AC power on LED.
- ◆ If the battery is low or missing, a chirp will be emitted when the red LED flashes. If the heat alarm is malfunctioning, the chirp is sounded without the red LED flashing. If AC power fails, the green LED will turn off.
- ◆ To test your heat alarm, direct a hair dryer at the sensor element (silver disk) at a 4-6" distance. Alternatively, a cordless soldering iron may be applied to the sensor element. The unit will return to normal standby mode once the disk cools down. A cold damp rag or sponge may be used to quickly cool the sensor.

NOTE: TANDEM INTERCONNECT MODELS.

- ◆ When testing one heat alarm, the heat alarm that is activated will flash the red indicator light and sound its alarm horn. All other units will sound the alarm horn with their red indicator lights remaining off. The relays will also activate on all units in tandem on models equipped with the relay option.

FIRE PROTECTION PLAN: WHAT YOU CAN DO TO MAKE YOUR FAMILY SAFE FROM FIRES

Please note that there are hazards against which heat detection may not be effective, such as smoking in bed, explosions, when a closed door separates the heat alarm from the source of the fire, etc. The ultimate responsibility for fire protection rests solely on you.

Installing heat alarms is just the first step in protecting your family from fires. You also must reduce the chances that fires will start in your home and increase your chances of safely escaping if one does start. To have an effective fire safety program:

- Install smoke and heat alarms properly following the instructions in this manual. Keep your units clean. Test your alarm weekly and have unit repaired or replace alarm when it when it no longer functions.** As with any electronic product, smoke and heat alarms have a limited life, and devices that don't work cannot protect you.
- Follow safety rules and prevent hazardous situations:**
 - ◆ Use smoking materials properly; never smoke in bed.
 - ◆ Keep matches and cigarette lighters away from children.
 - ◆ Store flammable materials in proper containers and never use them near open flames or sparks.
 - ◆ Keep electrical appliances and cords in good working order and do not overload electrical circuits.
 - ◆ Keep stoves, fireplaces, chimneys, and barbecue grills grease-free and make sure they are properly installed away from combustible materials.
 - ◆ Keep portable heaters and open flames such as candles away from combustible materials.
 - ◆ Do not allow rubbish to accumulate.
 - ◆ Do not leave small children home alone.
- Develop a family escape plan and practice it with your entire family, especially small children.**
 - ◆ Draw and post a floor plan of your home and find two ways to exit from each room. There should be one way to get out of each bedroom without opening the door.
 - ◆ Teach children what the smoke and heat alarm signal means, and that they must be prepared to leave the residence by themselves if necessary. Show them how to check to see if doors are hot before opening them, how to stay close to the floor and crawl if necessary, and how to use the alternate exit if the door is hot and should not be opened.
 - ◆ Decide on a meeting place a safe distance from your house and make sure that all your children understand that they should go and wait for you if there is a fire.
 - ◆ Hold fire drills at least every 6 months to make sure that everyone, even small children, know what to do to escape safely.
 - ◆ Know where to go to call the fire department from outside your residence.
 - ◆ Provide emergency equipment such as fire extinguishers and teach your family to use this equipment properly.
- Bedroom doors should be closed while sleeping if a smoke or heat alarm is installed in the bedroom.** They act as a barrier against heat and smoke.

WHAT TO DO IF THERE IS A FIRE IN YOUR HOME

If you have prepared family escape plans and practiced them with your family, you have increased their chances of escaping safely. Review the following rules with your children when you have fire drills so everyone will remember them in a real fire emergency:

- Don't panic; stay calm. Your safe escape may depend on thinking clearly and remembering what you have practiced.
- Get out of the house following a planned escape route as quickly as possible. Do not stop to collect anything or to get dressed.
- Open doors carefully only after feeling to see if they are hot. Do not open a door if it is hot; use an alternate escape route.
- Stay close to the floor; smoke and hot gases rise.
- Cover your nose and mouth with a cloth, wet if possible, and take short, shallow breaths.

- f. Keep doors and windows closed unless you open them to escape.
- g. Meet at your prearranged meeting place after leaving the house.
- h. Call the Fire Department as soon as possible from outside your house. Give the address and your name.
- i. Never re-enter a burning building.
Contact your local Fire Department for more information on making your home safer from fires and about preparing your family's escape plans.

NOTICE: CURRENT STUDIES HAVE SHOWN SMOKE ALARMS AND HEAT ALARMS MAY NOT AWAKEN ALL SLEEPING INDIVIDUALS, AND THAT IT IS THE RESPONSIBILITY OF INDIVIDUALS IN THE HOUSEHOLD THAT ARE CAPABLE OF ASSISTING OTHERS TO PROVIDE ASSISTANCE TO THOSE WHO MAY NOT BE AWAKENED BY THE ALARM SOUND, OR TO THOSE WHO MAY BE INCAPABLE OF SAFELY EVACUATING THE AREA UNASSISTED.

WHAT THIS HEAT ALARM CAN DO

This heat alarm is designed to sense heat produced by a fire.

⚠ WARNING HEAT ALARM WILL NOT SENSE SMOKE OR OTHER TOXIC GASES.

When properly located, installed, and maintained, this heat alarm is designed to provide warning of developing fires at a reasonable cost. This alarm monitors the air and, when it senses heat, activates its built-in alarm horn.

NOTICE: THIS HEAT ALARM IS DESIGNED FOR USE WITHIN SINGLE RESIDENTIAL LIVING UNITS ONLY; THAT IS, IT SHOULD BE USED INSIDE A SINGLE-FAMILY HOME OR ONE APARTMENT OF A MULTI-FAMILY BUILDING. IN A MULTI-FAMILY BUILDING, THE UNIT MAY NOT PROVIDE EARLY WARNING FOR RESIDENTS IF IT IS PLACED OUTSIDE OF THE RESIDENTIAL UNITS, SUCH AS ON OUTSIDE PORCHES, IN CORRIDORS, LOBBIES, BASEMENTS, OR IN OTHER APARTMENTS. IN MULTI-FAMILY BUILDINGS, EACH RESIDENTIAL UNIT SHOULD HAVE ALARMS TO ALERT THE RESIDENTS OF THAT UNIT. UNITS DESIGNED TO BE INTERCONNECTED SHOULD BE INTERCONNECTED WITHIN ONE FAMILY RESIDENCE ONLY; OTHERWISE, NUISANCE ALARMS WILL OCCUR WHEN AN ALARM IN ANOTHER LIVING UNIT IS TESTED.

NOTICE: WHAT HEAT ALARMS CANNOT DO

Heat alarms will not work without power. A battery must be connected to the alarm to maintain proper alarm operation if AC power supply is cut off by an electrical fire, an open fuse or circuit breaker, or for any other reason. In the event of AC power failure, the battery will supply power for a minimum of 24 hours.

Heat alarms may not sense a fire that starts where heat cannot reach the alarms such as in chimneys, in walls, on roofs, or on the other side of closed doors. Smoke alarms should also be placed in each bedroom as well as in the common hallway between them.

Heat alarms also may not sense a fire on another level of a residence or building. For example, a second-floor alarm may not sense a first-floor or basement fire. Therefore, **alarms should be placed on every level of a residence or building.**

The horn in your heat alarm meets or exceeds current audibility requirements of ANSI/UL 539. However, **if the heat alarm is located outside a bedroom, it may not wake up a sound sleeper**, especially if the bedroom door is closed or only partly open. If the alarm is located on a different level of the residence than the bedroom, it is even less likely to awaken people sleeping in the bedroom. In such cases, the National Fire Protection Association recommends that the alarms be interconnected so that an alarm on any level of the residence will sound an alarm loud enough to awaken sleepers in closed bedrooms. This can be done by employing a systematic approach by interconnecting a fire-detection system, by connecting units together, or by using radio frequency transmitters and receivers.

All types of smoke and heat alarm sensors have limitations. No type of smoke or heat alarm can sense every kind of fire every time. In general, alarms may not always warn you about fires caused by violent explosions, escaping gas, improper storage of flammable materials, or arson. These types of fires include:

- 1) Fires where the victim is intimate with a flaming initiated fire; for example, when a person's clothes catch on fire while cooking.
- 2) Fires where the smoke and/or heat is prevented from reaching the smoke or heat alarm due to a closed door or other obstruction.
- 3) Incendiary fires where the fire grows so rapidly that an occupant's egress is blocked even with properly located smoke alarms and heat alarms.

NOTICE:

- ◆ THIS HEAT ALARM IS NOT DESIGNED TO REPLACE SPECIAL-PURPOSE FIRE DETECTION AND ALARM SYSTEMS NECESSARY TO PROTECT PERSONS AND PROPERTY IN NON-RESIDENTIAL BUILDINGS SUCH AS WAREHOUSES, OR OTHER LARGE INDUSTRIAL OR COMMERCIAL BUILDINGS. IT ALONE IS NOT A SUITABLE SUBSTITUTE FOR COMPLETE FIRE-DETECTION SYSTEMS DESIGNED TO PROTECT INDIVIDUALS IN HOTELS AND MOTELS, DORMITORIES, HOSPITALS, OR OTHER HEALTH AND SUPERVISORY CARE AND RETIREMENT HOMES. PLEASE REFER TO NFPA 101, THE LIFE SAFETY CODE, AND NFPA 72 FOR SMOKE ALARM REQUIREMENTS FOR FIRE PROTECTION IN BUILDINGS NOT DEFINED AS "HOUSEHOLDS."
- ◆ THIS DEVICE WILL NOT SOUND FOR A CARBON MONOXIDE (CO) EVENT WHEN TANDEM INTERCONNECTED TO A GENTEX CO OR SMOKE/CO ALARM

Installing smoke and heat alarms may make you eligible for lower insurance rates, **but smoke alarms and heat alarms are not a substitute for insurance.** Homeowners and renters should continue to insure their lives and property.

HEAT DETECTION

General - NFPA 72 does not require heat alarms as part of the basic protection scheme, it is recommended that the householder consider the use of additional heat alarms for the same reasons presented in the next section. The additional areas lending themselves to protection with heat alarms are the dining room, attic (finished or unfinished), furnace room, utility room, basement and integral or attached garage. For bedrooms, the installation of a smoke alarm is recommended over the installation of a heat alarm for protection of the occupants from fires in their bedrooms.

Heat Alarm Mounting - Dead Air Space. Heat from a fire rises to the ceiling, spreads out across the ceiling surface, and begins to bank down from the ceiling. The corner where the ceiling and the wall meet is an air space into which heat has difficulty penetrating. In most fires, this dead air space measures about 4 inches (0.1 meter) down the wall as shown in FIGURE 6. Heat alarms should not be placed in this dead air space.

The placement of the heat alarm is critical where maximum speed of fire detection is desired. Thus, a logical location for a heat alarm is the center of the ceiling. At this location, the alarm is closest to all areas of the room.

If the heat alarm cannot be located in the center of the ceiling, an off-center location on the ceiling may be permitted to be used.

Per **NFPA 72, 2013 29.8.4.3** Heat alarms shall be mounted on the ceiling at least 4 inches (100mm) from a wall or on a wall with the top of the alarm not less than 4 inches (100mm), no more than 12 inches (300 mm), below the ceiling.

The Spacing of Heat Alarms. Where a room is too large for protection by a single heat alarm (50 ft. spacing), several heat alarms should be used. It is important that they be properly located so all parts of the room are covered.

Where the Distance Between Heat Alarms Should Be Further Reduced. The distance between heat alarms is based on data obtained from the spread of heat across a smooth ceiling. Where the ceiling is not smooth, the placement of the heat alarm should be tailored to the situation.

For instance, with open wood joists, heat travels freely down the joist channels so that the maximum distance between alarms, 50 ft. (15 m), may be permitted to be used. However, heat has trouble spreading across the joists, so the distance in this direction should be ½ the distance allowed between heat alarms, as shown in FIGURE 1, and the distance to the wall is reduced to 12 ½ ft. (3.8 m). Since ½ x 50 ft. (15 m) is 25 ft. (7.6 m), the distance between alarms across open wood joists should not exceed 25 ft. (7.6 m), as shown in FIGURE 1, and the distance to the wall is reduced [½ x 25 ft. (7.6 m)] to 12.5 ft. (3.8 m). The alarms are required to be mounted on the bottom of the joists and not up in joist channels.

Walls, partitions, doorways, ceiling beams and open joists interrupt the normal flow of heat, thus creating new areas to be protected.

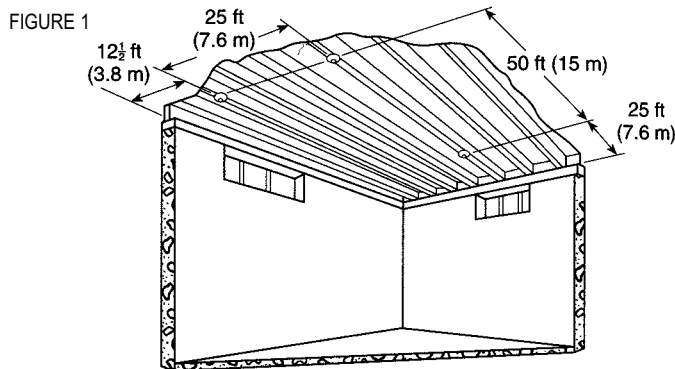

Open joists, attics and extra high ceilings are some of the areas that require special knowledge for installation.

PLACEMENT OF HEAT ALARMS

THIS EQUIPMENT SHOULD BE INSTALLED IN ACCORDANCE WITH THE NATIONAL FIRE PROTECTION ASSOCIATION'S STANDARD 72 (National Fire Protection Association, Batterymarch Park, Quincy, MA 02269).

For your information, the National Fire Protection Association's Standard 72, reads as follows:

NFPA 72, 2013 Edition, Chapter 29, Section 29.5.1.1 Where required by applicable laws, codes or standards for a specific type of occupancy, approved single and multiple-station smoke alarms shall be installed as follows:

29.5.1.1 Where required by applicable laws, codes or standards for a specific type of occupancy, approved single and multiple-station smoke alarms shall be installed as follows:

- 1) In all sleeping rooms and guest rooms
- 2) Outside of each separate dwelling unit sleeping area, within 6.4m (21ft) of any door to a sleeping room, the distance measured along a path of travel

- 3) On every level of a dwelling unit, including basements
- 4) On every level of a residential board and care occupancy (small facility), including basements and excluding crawl spaces and unfinished attics
- 5) In the living area(s) of a guest suite
- 6) In the living area(s) of a residential board and care occupancy (small facility)

29.5.1.2 Where the area addressed in 29.5.1.1(2) is separated from the adjacent living areas by a door, a smoke alarm shall be installed in the area between the door and the sleeping room, and additional alarms shall be installed on the living area side of the door as specified by 29.5.1.1 and 29.5.1.3.

29.5.1.3 In addition to the requirements of 29.5.1.1(1) through 29.5.1.1(3), where the interior floor area for a given level of a dwelling unit, excluding garage areas, is greater than 93m² (1000ft²), smoke alarms shall be installed per 29.5.1.3.1 and 29.5.1.3.2.

29.5.1.3.1 All points on the ceiling shall have a smoke alarm within a distance of 9.1m (30ft) travel distance or shall have an equivalent of one smoke alarm per 46.5m² (500ft²) is evaluated by dividing the total interior square footage of floor area per level by 46.5m² (500ft²).

29.5.1.3.2 Where dwelling units include great rooms or vaulted/cathedral ceilings extending over multiple floors, smoke alarms located on the upper floor that are intended to protect the aforementioned area shall be permitted to be considered as part of the lower floor(s) protection scheme used to meet the requirements of 29.5.1.3.1.

The installation of additional alarms of either the smoke, heat or CO type should result in a higher degree of protection. Adding alarms to rooms that are normally closed off from the required alarms increases the escape time because the fire does not need to build to the higher level necessary to force smoke out of the closed room to the required alarms. As a consequence, it is recommended that the householder consider the installation of additional fire protection devices.

However, it should be understood that NFPA 72 does not require additional smoke alarms over and above those called for in FIGURES 2, 3, 4 and 5 where required smoke alarms are shown.

FIGURE 2

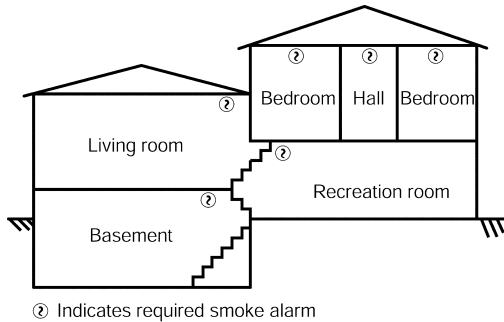

FIGURE 2: A SMOKE ALARM MUST BE LOCATED ON EVERY LEVEL OF DWELLING UNIT, INCLUDING BASEMENT, WITHIN EACH SLEEPING ROOM AND OUTSIDE SLEEPING AREAS.

Where to Locate the Required Smoke Alarms. The major threat from fire in a dwelling unit occurs at night when everyone is asleep. Persons in sleeping areas can be threatened by fires in the remainder of the unit; therefore, smoke alarms are best located in each bedroom and between the bedroom areas and the rest of the unit as shown in FIGURE 3.

FIGURE 3

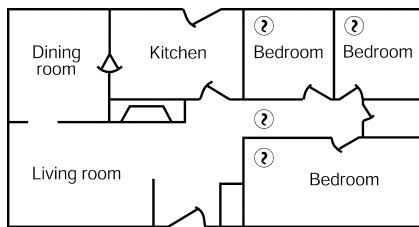

FIGURE 3: A SMOKE ALARM MUST BE LOCATED BETWEEN THE SLEEPING AREA AND THE REST OF THE DWELLING UNIT AS WELL AS IN EACH BEDROOM.

In dwelling units with more than one bedroom area or with bedrooms on more than one floor, more than one smoke alarm is required, as shown in FIGURE 4.

FIGURE 4

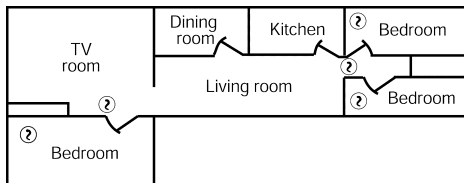

FIGURE 4: IN DWELLING UNITS WITH MORE THAN ONE SLEEPING AREA, A SMOKE ALARM MUST BE PROVIDED TO PROTECT EACH SLEEPING AREA IN ADDITION TO SMOKE ALARMS REQUIRED IN BEDROOMS.

In addition to smoke alarms outside of the sleeping areas and in each bedroom, NFPA 72 requires the installation of a smoke alarm on each additional level of the dwelling unit, including the basement. These installations are shown in FIGURE 5. The living area smoke alarm should be installed in the living room or near the stairway to the upper level, or in both locations. The basement smoke alarm should be installed in close proximity to the stairway leading to the floor above. Where installed on an open-joisted ceiling, the smoke alarm should be placed on the bottom of the joists. The smoke alarm should be positioned relative to the stairway so as to intercept smoke coming from a fire in the basement before the smoke enters the stairway.

FIGURE 5

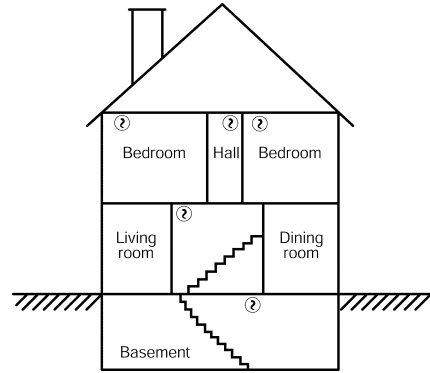

FIGURE 5: A SMOKE ALARM MUST BE LOCATED ON EACH LEVEL IN ADDITION TO EACH BEDROOM.

IMPORTANT CONSIDERATION

NFPA 72, 2013 Edition, Chapter 29, Section 29.8.1.4(5)(b) states: “Smoke alarms installed in one- and two-family dwellings shall not remain in service longer than 10 years from the date of manufacture.” Smoke alarms should be replaced for the following reasons:

- Dust, dirt, and other environmental contaminants can affect your smoke and heat alarm over a prolonged period.
- Fast changing industry consensus standards and codes on all smoke and heat alarms make it advisable to periodically upgrade your devices to maximize life safety.
- Assurance that your smoke and heat alarm needs are kept abreast with the constantly improving electronic technology.
- Smoke and heat alarms are recognized as one of the lowest cost ways to protect dwelling inhabitants against the danger of fire(s). It makes good common sense to periodically replace and update your smoke alarm that contributes so much to life safety.

MOUNTING LOCATION

This heat alarm can be mounted on a ceiling or wall with equal efficiency in either location.

- **Ceiling location**-heat alarm should be mounted at least 4 inches (100 mm) from a wall.
- **Wall location**-locate the top of the heat alarm not less than 4 inches (100 mm) or more than 12 inches (300mm) from the ceiling.

FIGURE 6

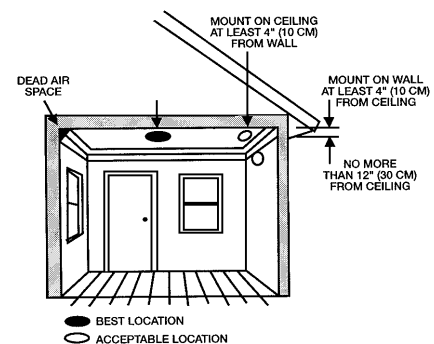

FIGURE 6: RECOMMENDED HEAT ALARM MOUNTING LOCATIONS

The placement of the alarm is critical if maximum speed of fire detection is desired. Thus, a logical location for a alarm is the center of the ceiling. At this location, the alarm is closest to all areas of the room.

Figures 2, 3, 4 & 5 are reprinted with permission from NFPA 72, National Fire Alarm Code®, Copyright ©2010, National Fire Protection Association, Quincy, MA 02169. This reprinted material is not the complete and official position of the National Fire Protection Association on the referenced subject which is represented only by the standard in its entirety. National Fire Alarm Code® and NFPA 72® are registered trademarks of the National Fire Protection Association, Inc., Quincy, MA 02169.

LOCATIONS TO AVOID

Placing heat alarms where they will not operate properly causes nuisance alarms.

To avoid nuisance alarms, do not place heat alarms:

- Where temperatures are regularly below 40°F (4.44°C) or above 100°F (37.78°C).
- In air streams passing by kitchens. It is possible normal air currents can draw cooking heat into the sensor of a unit near the kitchen. If you experience frequent unwanted alarms from a unit near your kitchen, try relocating it. Do not install your heat alarm over a stove or a range.
- In dead air spaces at the top of a peaked roof or in the corners between ceilings and walls. Dead air may prevent heat from reaching a alarm. See FIGURES 1 and 6 for recommended mounting locations.
- Near fluorescent light fixtures. Electrical "noise" from nearby fluorescent light fixtures may cause a nuisance alarm. Install alarms and fluorescent light on separate electrical circuits

⚠ WARNING Never disconnect an AC alarm to silence a nuisance alarm. Use a cold damp rag or sponge and apply to the heat sensor (silver disk) on the face of the unit. The alarm will automatically turn off when the temperature of the sensor falls below 135°F. Do not unnecessarily stand close to the alarm. The sound produced by the alarm is loud because it is designed to awaken you in an emergency. Prolonged exposure to the horn at a close distance may be harmful to your hearing.

INSTALLATION OF HD135

New Construction: alarm head should not be installed until **AFTER** sanding, painting, and other dust creating situations are finished and cleaned up.

MOUNTING OUTLET BOX

Use a 2" x 3" switch box or a 4" square or octagon junction box. Mount a box for each alarm. If wall mounting is desired, be sure the box screws are oriented to upper right and lower left corners. Be sure to use supplied Mounting Plate.

WIRING/GENERAL

1. Use ANSI/UL Listed cable with Class1 insulation.
2. Observe local code requirements. Use the box clamps to anchor cable to outlet box.
3. Metal outlet boxes must be grounded to earth ground.
4. **NOTICE:** USE ONLY DURACELL® MN 1604 BATTERY WITH THE HD135 HEAT ALARM.

CAUTION: Turn off electricity to prevent SHOCK and damage to alarm. Be sure the power line to the alarm is **not** controlled by any on/off switch, or other type of switch, other than a fuse or circuit breaker.

IMPORTANT: Insure that all fluorescent lighting fixtures are properly grounded.
NOTICE: THE WIRING TO BE USED SHALL BE IN ACCORDANCE WITH THE PROVISIONS OF ARTICLE 300.3 (B) 210 OF THE NATIONAL ELECTRICAL CODE, NFPA 70. WIRE INSTALLATION SHOULD BE PERFORMED ONLY BY A LICENSED ELECTRICIAN.

WIRING ONE HEAT ALARM

1. Run a minimum of 16 gauge, 2-conductor cable, plus ground (3 wires) to the alarm junction box from a power supply. Use ANSI/UL Listed Class 1 wire.
NOTICE: THE WIRING TO BE USED SHALL BE IN ACCORDANCE WITH THE PROVISIONS OF ARTICLE 300.3(B) 210 OF THE NATIONAL ELECTRICAL CODE, NFPA 70.
2. Make wire connections to the supplied plug-in connector as follows: black to black, white to white, and connect the ground wire to the metal outlet box.

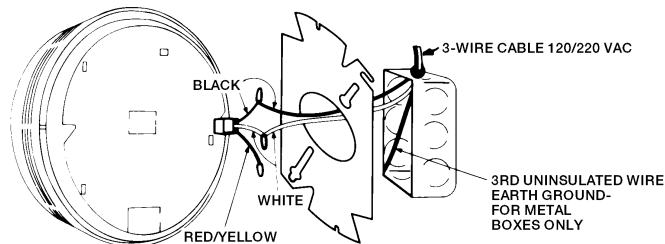

NOTICE: RED-YELLOW WIRE: THE RED-YELLOW WIRE FROM THE HEAT ALARM IS FOR TANDEM CONNECTION ONLY. DO NOT USE, AND DO NOT REMOVE INSULATION CAP UNLESS CONNECTING ANOTHER HEAT ALARM.

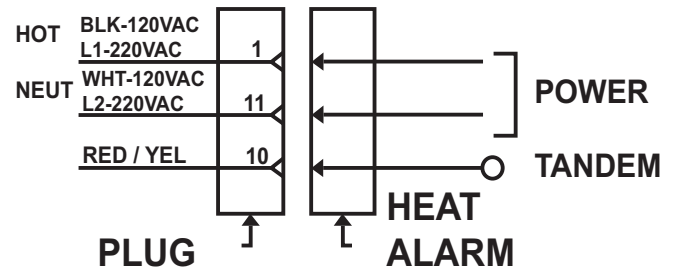

WIRING TWO OR MORE HEAT ALARMS

Tandem Installation

NOTICE: ALL HEAT ALARMS IN A TANDEM INSTALLATION MUST BE CONTROLLED BY THE SAME FUSE OR CIRCUIT BREAKER. OTHERWISE TANDEM UNITS WILL NOT OPERATE. TANDEM UNITS WILL OPERATE IN THE EVENT OF AC POWER FAILURE IF BATTERY IS CONNECTED TO THE HEAT ALARM.

LIMITATIONS: A maximum of (12) smoke alarms (9123, 9123H, 9123T, 9223, 9223H, 9223T, GN-300, S1209 or S1209F) may be tandem connected together. A total of (12) smoke alarms and (6) heat alarms may be tandem interconnected together. Do not exceed 125 feet between each alarm. Do not exceed 1125 feet between first and last alarm.

A maximum of six (6) smoke alarms with relay options (9123F, 9123HF, 9123TF, 9223F, 9223HF, 9223TF or 7139CS) may be tandem interconnected. If a HD135 is interconnected, a maximum of (5) 9123F, 9223F, S1209F or 7139CS and (3) HD135 units may be tandem interconnected.

Wire used for interconnecting shall be in accordance with the latest edition of Article 760 of the National Electrical Code (NEC) and NFPA 70, and must not exceed a resistance of 10 ohms.

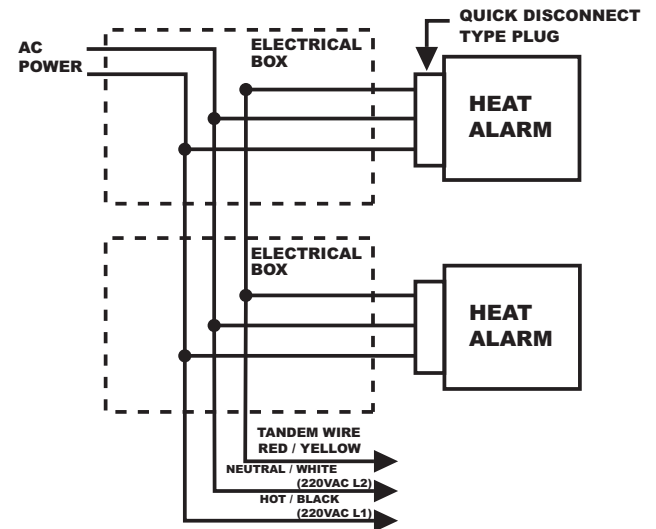

1. Run a minimum of 16 gauge, 3-conductor cable, plus ground (4 wires) to the first alarm junction box from a power supply and between all alarms that are to be tandem connected together. Use ANSI/UL Listed Class 1 wire.
2. Make wire connections to the supplied plug-in connector as follows: black to black, white to white, 3rd conductor to the red/yellow wire. The red/yellow wire should be stripped to make the connection. Connect ground wire between metal outlet boxes.

NOTICE: TANDEM INTERCONNECTING MODELS

- **DO NOT** connect Gentex smoke or heat alarms to other manufacturers' smoke alarms.
- All units connected in tandem **MUST** get their power from the same circuit, that is, all heat and/or smoke alarms in tandem must be controlled by the same fuse or circuit breaker.
- After installation to verify proper working conditions all horns must sound in this system.

CAUTION: Failure to observe any of the conditions set forth may cause system malfunction and damage to the alarm.

BATTERY INSTALLATION

1. Remove heat alarm from mounting plate by turning counter-clockwise.
2. Remove AC power connector and unplug power leads from the top of the old battery. Snap new battery onto snaps and reinsert battery through hole in the back of the alarm. **CAUTION:** Units with battery back-up will not provide power or transmit an alarm to AC only units in the event of an AC power failure. All battery back-up units in tandem with good batteries will operate normally during an AC power failure.
3. Use only Duracell® MN 1604 battery with the HD135 Series heat alarm.

CAUTION: Units with battery back-up will not provide power or transmit an alarm to AC only units in the event of an AC power failure. All battery back-up units in tandem, with good batteries, will operate normally during an AC power failure.

MOUNTING: PLATE & HEAT ALARM

1. Lace the connector through the provided mounting plate and secure the plate to the junction box.
2. Plug the wire connector into the heat alarm base.

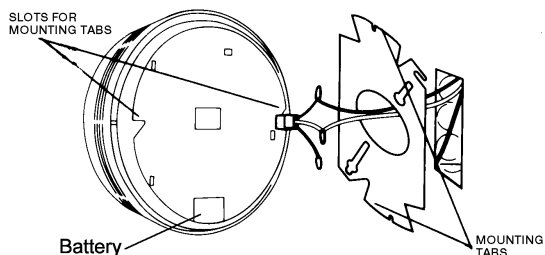

3. Place the heat alarm up to the mounting plate, rotating it clockwise until alarm firmly snap locks into place. Keep the heat alarm parallel to the mounting plate so upper and lower tabs on the plate seat correctly into the heat alarm.

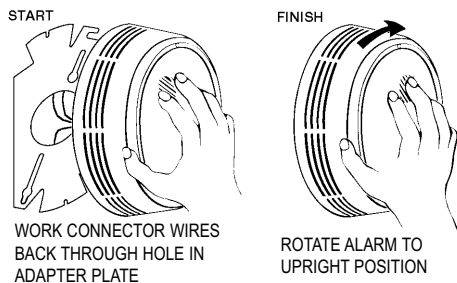

TESTING

Use a hair dryer and direct hot air towards the silver disk on the face of the alarm or use a portable soldering iron and place it against the heat sensor.

⚠ WARNING

- ◆ **Never use an open flame of any kind to test your heat alarm. You may ignite and damage the alarm as well as your home.**
- ◆ **Heat alarms are not to be used with alarm guards unless the combination has been evaluated and found suitable for that purpose.**

TO RETURN A HEAT ALARM

Should you experience problems with your heat alarm, proceed as follows:

1. Turn off electrical power to the heat alarm.
2. Twist the heat alarm counter-clockwise to remove it from its mounting plate.
3. Unplug the connector from the back of the heat alarm. Do not remove the wire connection; leave the connector for your replacement heat alarm.
4. Remove battery from heat alarm. Do not ship heat alarm with battery still attached to battery clip.
5. Carefully pack (the manufacturer cannot be responsible for consequential damage) and return to the manufacturer. Include complete details as to exact nature of difficulties being experienced and date of installation.
6. Return to: Gentex Corporation, 10985 Chicago Drive, Zeeland, Michigan, 49464. Prior to returning, call Gentex at 1-800-436-8391 or e-mail FP_RMA@gentex.com to obtain a RMA Number from our Customer Service Department.

LIMITED WARRANTY

For a period of 12 months from the date of purchase or a maximum of 18 months from the date of manufacture (or as long as required by applicable law), Gentex warrants to you the original purchaser that your appliance will be free from defects in workmanship and materials under normal use and service.

This warranty does not apply and is void if damage or failure is caused by: accident, abuse, misuse, abnormal use, faulty installation, liquid contact, fire, earthquake or other external cause; operating the appliance outside Gentex's published guidelines; or service, alteration, maintenance or repairs performed by anyone other than Gentex. This warranty also does not apply to: consumable parts, such as batteries; cosmetic damage, including but not limited to scratches or dents; defects caused by normal wear and tear or otherwise due to the normal aging of the appliance, or if any serial number has been removed or defaced from the appliance.

TO THE EXTENT PERMITTED BY LAW, THIS WARRANTY AND THE REMEDIES SET FORTH HEREIN ARE EXCLUSIVE AND IN LIEU OF ALL OTHER WARRANTIES, REMEDIES AND CONDITIONS, WHETHER ORAL, WRITTEN, STATUTORY, EXPRESS OR IMPLIED. GENTEX DISCLAIMS ALL STATUTORY AND IMPLIED WARRANTIES, INCLUDING WITHOUT LIMITATION, WARRANTIES OF MERCHANTABILITY AND FITNESS FOR A PARTICULAR PURPOSE AND WARRANTIES AGAINST HIDDEN OR LATENT DEFECTS TO THE EXTENT PERMITTED BY LAW. TO THE EXTENT SUCH WARRANTIES CANNOT BE DISCLAIMED, SUCH IMPLIED WARRANTIES SHALL APPLY ONLY FOR THE WARRANTY PERIOD SPECIFIED ABOVE. PLEASE NOTE THAT SOME STATES (COUNTRIES AND PROVINCES) DO NOT ALLOW LIMITATION ON HOW LONG AN IMPLIED WARRANTY (OR CONDITION) LASTS. SO THE ABOVE LIMITATION MAY NOT APPLY TO YOU.

EXCEPT AS PROVIDED IN THIS WARRANTY AND TO THE EXTENT PERMITTED BY LAW, GENTEX WILL NOT BE LIABLE FOR ANY DIRECT, SPECIAL, INCIDENTAL OR CONSEQUENTIAL DAMAGES RESULTING FROM ANY BREACH OF WARRANTY OR CONDITION, OR ARISING IN CONNECTION WITH THE SALE, USE OR REPAIR OF THE APPLIANCE, OR UNDER ANY OTHER LEGAL THEORY, INCLUDING BUT NOT LIMITED TO LOSS OF USE, LOSS OF REVENUE, LOSS OF ACTUAL OR ANTICIPATED PROFITS, LOSS OF THE USE OF MONEY, LOSS OF BUSINESS, LOSS OF OPPORTUNITY, LOSS OF GOODWILL, AND LOSS OF REPUTATION. THE MAXIMUM LIABILITY OF GENTEX SHALL NOT IN ANY CASE EXCEED THE PURCHASE PRICE PAID BY YOU FOR THE APPLIANCE. PLEASE NOTE THAT SOME STATES (COUNTRIES AND PROVINCES) DO NOT ALLOW THE EXCLUSION OR LIMITATION OF INCIDENTAL OR CONSEQUENTIAL DAMAGES, SO THE ABOVE LIMITATION OR EXCLUSION MAY NOT APPLY TO YOU.

If a defect in workmanship or materials causes your appliance to become inoperable within the warranty period, you must return the appliance to Gentex postage prepaid to: Gentex Corporation, 10985 Chicago Dr., Zeeland MI 49464. You must prove to the satisfaction of Gentex the date of purchase of your appliance. You must also enclose a return address. Warranty service may only be performed by Gentex personnel at Gentex's facilities in Zeeland, Michigan. You must also pack the appliance to minimize the risk of it being damaged in transit. If we receive an appliance in a damaged condition as the result of shipping, we will notify you and you must seek a claim with the shipper.

If you submit a valid claim to Gentex during the warranty period, Gentex will, at its option, repair your appliance or furnish you with a new or rebuilt appliance without charge to you except for postage required to return the appliance to us. Gentex will not reimburse you for repairs or replacement parts provided by other parties. Your repaired or replacement appliance will be returned to you free of charge and it will be covered under the warranty for the balance of the warranty period, if any. When a product or part is replaced, any replacement item becomes your property and the replaced item becomes property of Gentex. For additional warranty and product information go to www.gentex.com.

THIS WARRANTY GIVES YOU SPECIFIC LEGAL RIGHTS AND YOU MAY ALSO HAVE OTHER RIGHTS WHICH VARY FROM STATE TO STATE (OR BY COUNTRY OR PROVINCE). BY THIS WARRANTY, GENTEX DOES NOT LIMIT OR EXCLUDE YOUR RIGHTS EXCEPT AS ALLOWED BY LAW. TO FULLY UNDERSTAND YOUR RIGHTS, YOU SHOULD CONSULT THE LAWS OF YOUR COUNTRY, PROVINCE OR STATE.

Important Notice:

These materials have been prepared by Gentex Corporation ("Gentex") for informational purposes only, are necessarily summary, and are not purported to serve as legal advice and should not be used as such. Gentex makes no representations and warranties, express or implied, that these materials are complete and accurate, up-to-date, or in compliance with all relevant local, state and federal laws, regulations and rules. The materials do not address all legal considerations as there is inevitable uncertainty regarding interpretation of laws, regulations and rules and the application of such laws, regulations and rules to particular fact patterns. Each person's activities can differently affect the obligations that exist under applicable laws, regulations or rules. Therefore, these materials should be used only for informational purposes and should not be used as a substitute for seeking professional legal advice. Gentex will not be responsible for any action or failure to act in reliance upon the information contained in this material.

GENTEX CORPORATION
10985 CHICAGO DRIVE, ZEELAND, MI 49464
PHONE: 1-800-436-8391
www.gentex.com